



廣益全球驗證有限公司
新北市中和區橋和路120號9樓之二
TEL: 886 - 2 - 2248.0810
Fax: 886 - 2 - 2248.0811

Great One Global Certification Co Ltd
9F-2, No.120, Qiaohe Rd., Zhonghe Dist.,
New Taipei City 235, Taiwan (R.O.C.)
Email: sales@go-safety.com.tw

Goniophotometer Measurement Report For Luminaires

Applicant : Top-Win Optoelectronics Corp.

Applicant Add : 5F-2, No.120, Qiaohe Rd, Zhonghe Dist.,
New Taipei City 235, Taiwan(R.O.C.)

Report No : GO1206180101

Product Name : LED Street Ligjt

Model No : TW-PI2108W03

Sample No : 12061801-1

Test Specification : IESNA LM-79-08, Approved Method: Electrical and
Photometric Measurements of Solid-State Lighting
Products.(Deviation - Type C Goniophotometer of
Rotating Luminaire)

Test Date : 2012-6-20

Issue Date : 2012-6-25

- Note: 1. The test results of this report relate only to the tested sample identified in this report.
2. This report shall not be reproduced, in full or in portion, except for having written approval from Great One Global Certification Co. , Ltd.
3. The data in report cannot be used for advertisement, publication and promotion.

Tested By:

Reviewed By:

Eason Yang

David Yuan

Project Engineer

Manager

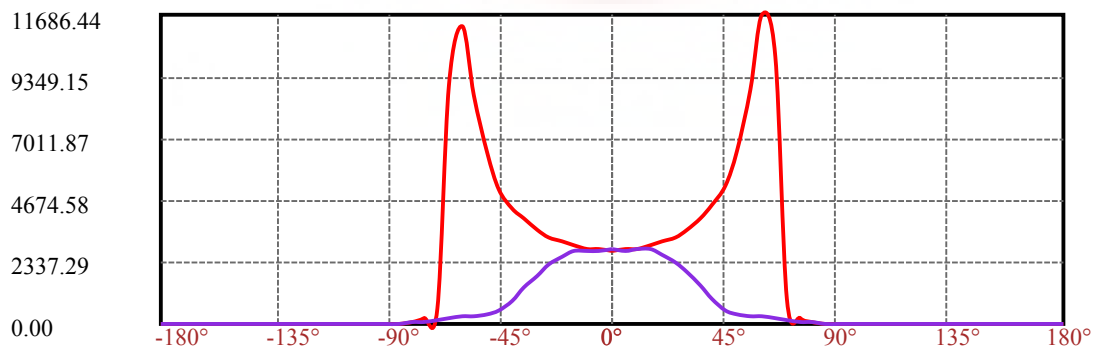
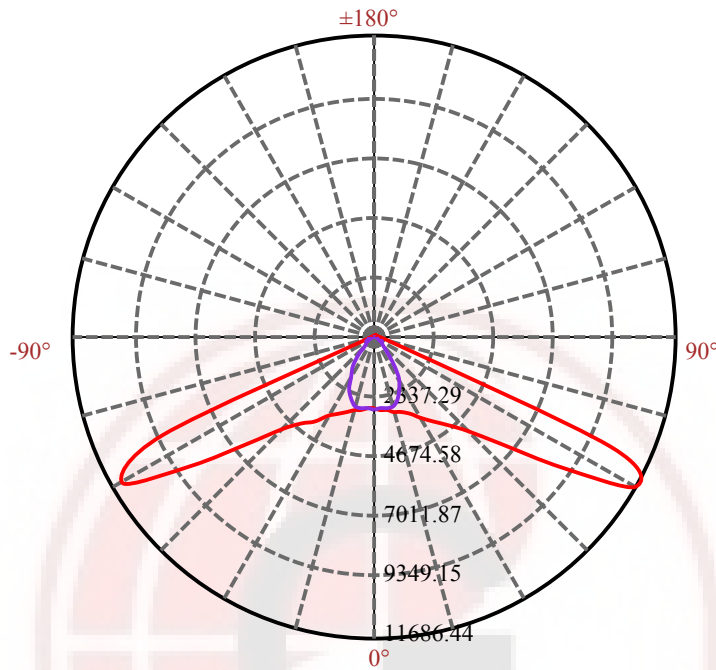

C0/C180: —————
 C90/C270: —————

Lux distance Curve"

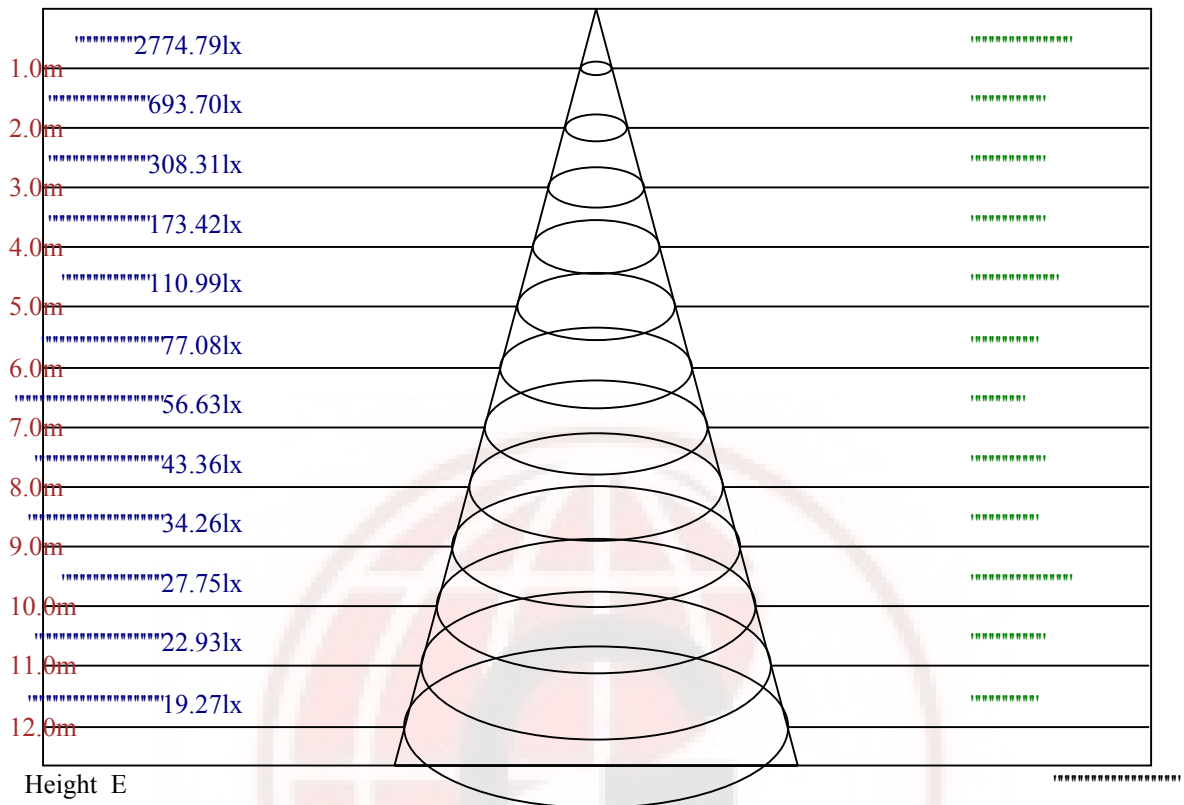

ISO-Intensity(V-H)"

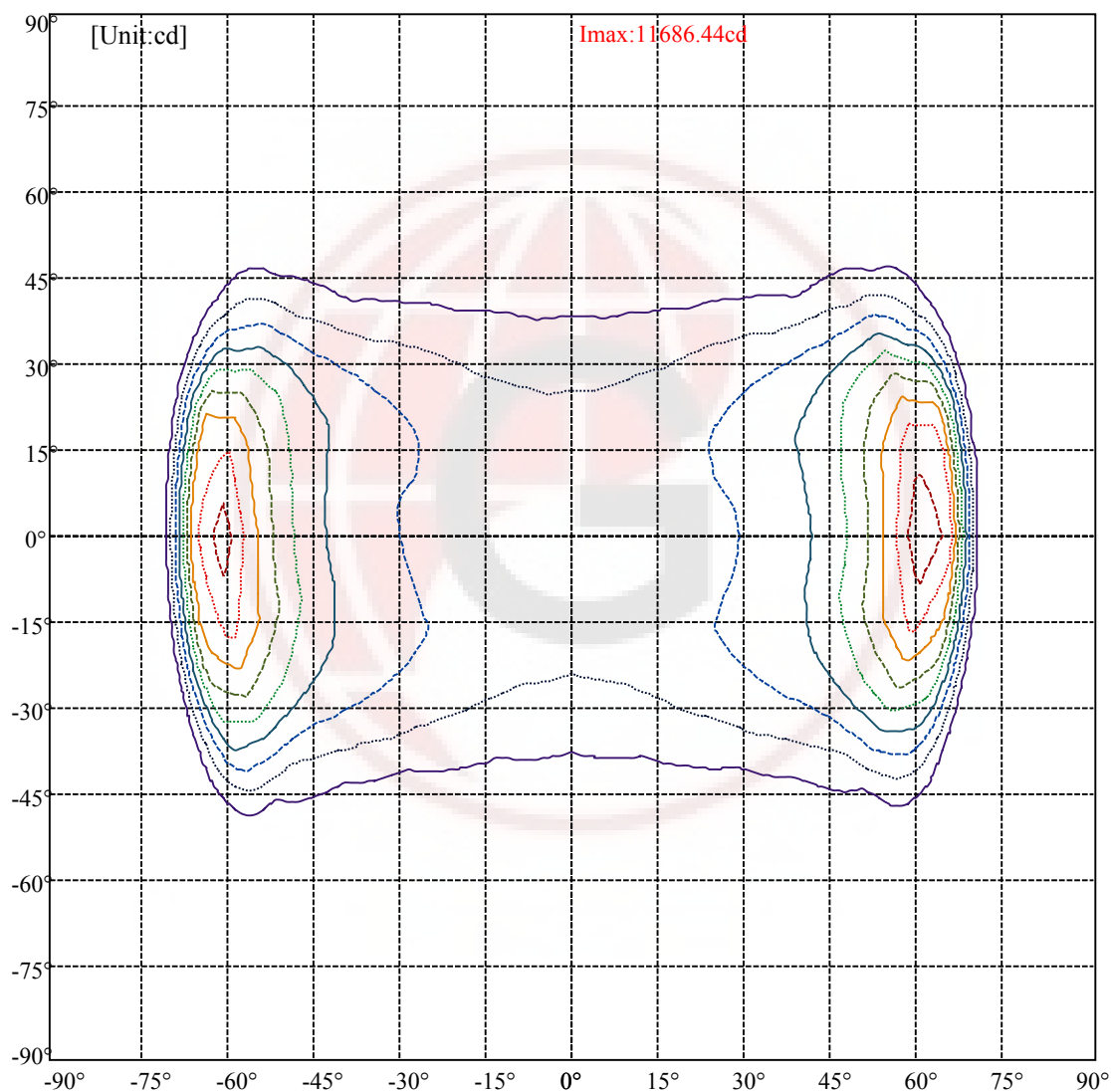

- (10%Imax) 1168.64
- (20%Imax) 2337.29
- (30%Imax) 3505.93
- (40%Imax) 4674.58
- (50%Imax) 5843.22
- (60%Imax) 7011.87
- (70%Imax) 8180.51
- (80%Imax) 9349.15
- (90%Imax) 10517.8

Equipment: GMS1800
Temperature(°C): 25.8

Date: 2012/6/20
Humidity(%): 61.0%

Operator: Eason Yang
Distance(m): 12.65

ISO illuminance diagram"

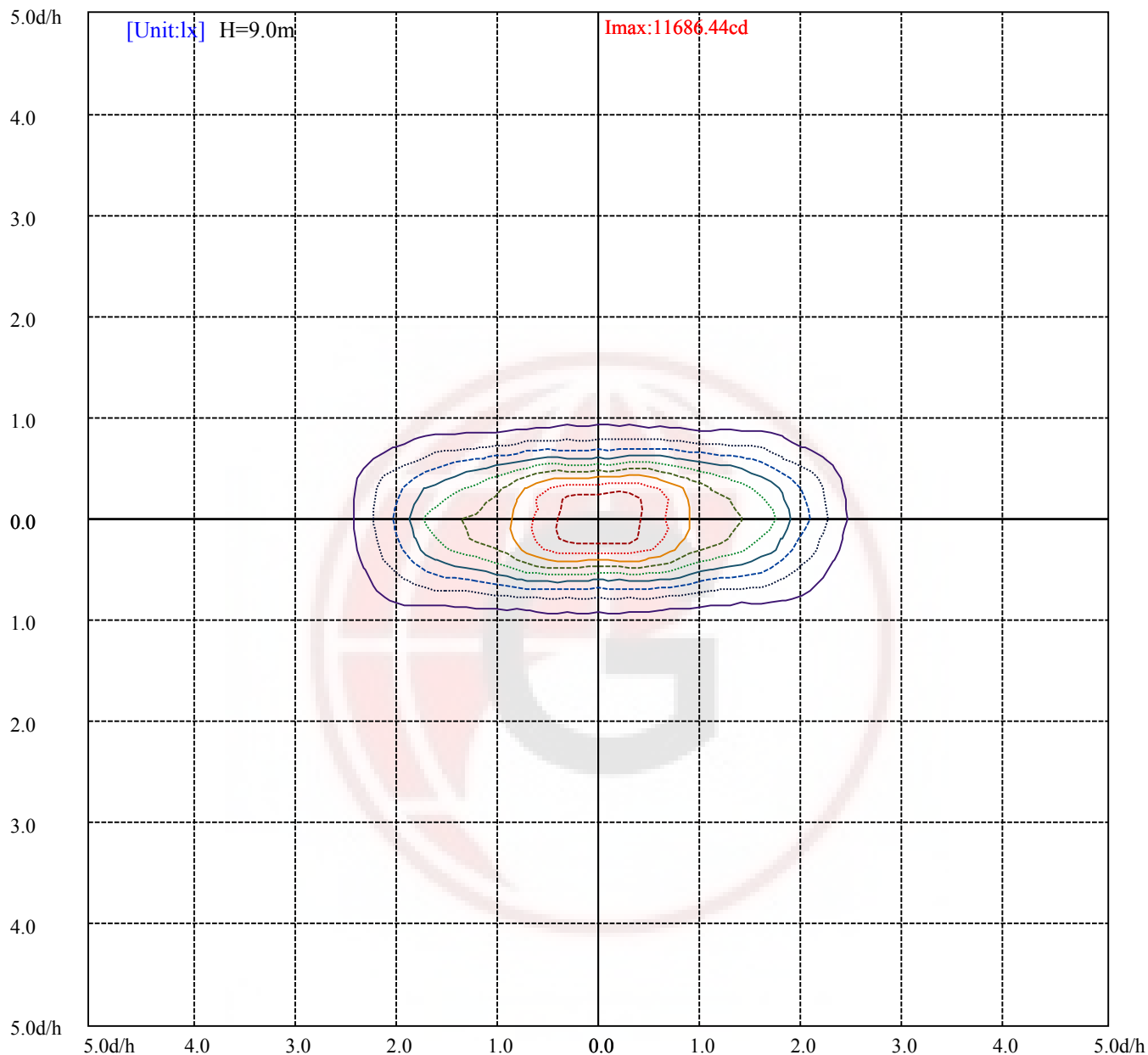

(10%Emax) 3.471099	———
(20%Emax) 6.94221
(30%Emax) 10.41331	- - - - -
(40%Emax) 13.88444	———
(50%Emax) 17.35556
(60%Emax) 20.82667	- - - - -
(70%Emax) 24.29778	———
(80%Emax) 27.76889
(90%Emax) 31.24	- - - - -

Equipment: GMS1800
Temperature(°C): 25.8

Date: 2012/6/20
Humidity(%): 61.0%

Operator: Eason Yang
Distance(m): 12.65

Top-Win Optoelectronics Corp. "

Intensity data(cd)"

C/γ(°)	0.0	5.0	10.0	15.0	20.0	25.0	30.0	35.0	40.0
0.0	2774.79	2803.59	2866.00	2987.62	3112.44	3288.46	3570.10	4008.56	4487.03
10.0	2829.20	2851.60	2918.81	3026.03	3146.04	3315.67	3608.51	4056.57	4554.24
20.0	2822.80	2843.60	2902.81	3016.42	3200.45	3414.88	3730.12	4184.59	4551.04
30.0	2814.80	2821.20	2866.00	2995.62	3178.05	3376.48	3627.71	3832.54	3986.16
40.0	2811.60	2805.19	2870.80	3006.82	3158.84	3291.66	3360.47	3320.47	3192.77
50.0	2811.60	2792.07	2841.52	2976.42	3051.95	3063.31	2985.54	2810.80	2397.46
60.0	2808.24	2786.47	2848.56	2923.61	2911.13	2754.79	2532.36	2138.86	1546.14
70.0	2802.15	2774.47	2818.48	2862.64	2782.79	2563.72	2220.47	1761.05	1200.97
80.0	2801.67	2768.23	2817.04	2815.92	2641.17	2364.81	1901.71	1447.72	976.14
90.0	2799.27	2762.47	2795.75	2798.95	2631.89	2339.69	1930.99	1428.36	975.02
100.0	2796.07	2762.15	2805.99	2792.71	2617.97	2314.41	1898.19	1420.68	947.97
110.0	2791.75	2758.79	2790.63	2829.68	2722.46	2508.51	2129.74	1668.39	1204.97
120.0	2788.71	2760.07	2804.07	2879.13	2825.04	2650.93	2404.18	1984.76	1463.25
130.0	2791.27	2765.19	2799.75	2918.65	2969.70	2934.01	2847.76	2661.17	2210.39
140.0	2784.39	2761.99	2816.40	2957.22	3075.63	3168.45	3193.25	3127.48	2959.14
150.0	2782.79	2769.99	2810.00	2928.41	3107.64	3270.86	3480.49	3637.31	3701.32
160.0	2779.59	2784.39	2835.60	2938.01	3102.84	3322.07	3586.10	3960.56	4275.80
170.0	2777.99	2785.99	2835.60	2933.21	3051.63	3197.25	3477.29	3894.95	4312.61
180.0	2774.79	2795.59	2859.60	2963.62	3099.64	3266.06	3534.90	3965.36	4362.21
190.0	2829.20	2853.20	2915.61	3014.82	3147.64	3314.07	3579.70	4027.77	4461.43
200.0	2822.80	2832.40	2875.60	2966.82	3110.84	3310.87	3603.71	3970.16	4354.21
210.0	2814.80	2818.00	2862.80	2970.02	3149.24	3350.87	3558.90	3771.73	3851.74
220.0	2811.60	2805.19	2830.80	2936.41	3072.43	3195.65	3270.86	3214.85	3104.44
230.0	2811.60	2789.67	2826.96	2937.21	2993.86	2981.38	2887.13	2685.66	2276.80
240.0	2808.24	2780.87	2805.03	2885.69	2854.48	2713.66	2480.83	2139.34	1653.19
250.0	2802.15	2772.87	2803.59	2830.32	2700.38	2463.71	2135.82	1658.15	1155.84
260.0	2801.67	2771.11	2784.23	2792.55	2640.37	2364.49	1974.20	1527.58	1063.03
270.0	2799.27	2763.75	2787.59	2769.99	2569.16	2256.64	1835.30	1399.56	899.17
280.0	2796.07	2767.75	2781.35	2795.75	2639.89	2342.57	1970.04	1541.66	1033.43
290.0	2791.75	2770.63	2798.15	2829.52	2695.10	2447.70	2109.74	1629.99	1134.08
300.0	2788.71	2776.71	2801.67	2885.53	2858.80	2702.46	2434.26	2098.06	1611.11
310.0	2791.27	2781.83	2826.48	2941.21	2997.54	2959.78	2853.84	2636.21	2164.14
320.0	2784.39	2787.59	2824.40	2939.61	3083.63	3187.65	3238.86	3150.84	3014.82
330.0	2782.79	2803.59	2853.20	2963.62	3162.04	3344.47	3562.10	3726.92	3758.93
340.0	2779.59	2806.80	2856.40	2962.02	3104.44	3307.67	3626.11	3992.56	4317.41
350.0	2777.99	2819.60	2891.61	2990.82	3126.84	3302.86	3589.30	4117.38	4520.64
360.0	2774.79	2803.59	2866.00	2987.62	3112.44	3288.46	3570.10	4008.56	4487.03

Equipment: GMS1800
 Temperature(°C): 25.8

Date: 2012/6/20
 Humidity(%): 61.0%

Operator: Eason Yang
 Distance(m): 12.65

Intensity data(cd)"

C/γ(°)	45.0	50.0	55.0	60.0	65.0	70.0	75.0	80.0	85.0
0.0	5203.93	6527.32	8863.65	11686.44	10119.82	916.93	224.19	64.33	10.40
10.0	5263.14	6565.72	8337.17	9988.60	9108.48	953.73	212.51	80.97	16.80
20.0	5024.71	5717.60	6432.90	6287.28	3155.00	349.81	138.58	48.97	6.88
30.0	4026.17	3872.54	3170.05	2125.10	896.13	203.55	116.34	52.17	10.88
40.0	2740.55	1844.90	916.77	335.89	218.91	143.06	88.65	41.61	7.84
50.0	1693.68	906.53	379.73	287.40	220.67	165.30	109.78	56.01	14.88
60.0	944.45	435.10	329.49	267.24	212.83	150.90	109.94	51.85	19.36
70.0	706.18	414.30	328.37	268.20	211.23	162.58	129.14	66.57	16.48
80.0	504.07	397.02	327.25	260.84	210.43	152.50	102.73	49.29	9.92
90.0	515.75	393.66	323.09	268.20	203.87	165.62	105.45	48.97	11.04
100.0	509.35	387.89	326.77	263.88	207.71	151.38	101.45	47.05	9.28
110.0	696.58	407.90	328.05	267.40	208.67	162.26	126.10	71.37	17.12
120.0	909.89	419.74	331.25	266.44	212.83	150.42	114.58	59.85	19.04
130.0	1589.02	835.80	365.01	287.24	221.47	167.70	117.78	61.93	20.48
140.0	2493.15	1616.39	868.76	315.24	213.15	152.18	94.73	45.13	10.88
150.0	3685.32	3427.68	2726.78	1742.65	852.92	199.87	124.34	54.73	14.56
160.0	4666.26	5117.52	5650.40	5264.74	3191.65	312.36	142.10	53.61	9.92
170.0	4917.49	6023.25	7557.86	9050.87	8359.58	1006.54	216.03	103.05	17.60
180.0	5067.91	6466.51	8642.81	11263.98	9031.67	608.25	221.31	58.09	9.28
190.0	5173.53	6557.72	8188.35	9654.16	7842.70	517.83	207.71	82.09	12.48
200.0	4722.26	5213.53	5893.63	6141.66	4909.49	867.32	173.46	79.85	14.56
210.0	3830.94	3637.31	2914.49	1965.08	863.16	205.31	118.42	53.29	10.72
220.0	2797.19	1974.68	1134.56	467.91	247.71	168.34	108.18	56.33	16.64
230.0	1590.94	846.36	380.21	289.80	225.47	168.82	110.58	56.49	11.84
240.0	1077.11	508.71	354.45	289.80	230.91	171.06	122.10	67.21	36.81
250.0	679.30	406.30	333.81	274.12	209.79	165.30	131.86	68.01	14.88
260.0	587.44	422.94	354.45	287.40	226.91	173.30	117.78	62.57	16.32
270.0	500.39	391.42	321.49	264.52	210.59	163.38	105.13	47.53	9.28
280.0	582.96	410.78	343.57	283.72	223.71	168.02	118.42	58.57	15.84
290.0	657.37	391.10	325.65	267.72	206.75	162.10	120.98	63.21	13.28
300.0	1008.94	473.99	344.05	280.04	225.31	166.26	121.30	68.17	37.13
310.0	1509.33	770.99	349.01	279.88	216.19	161.78	108.98	50.73	15.68
320.0	2622.77	1797.05	980.94	368.53	226.11	163.38	104.01	50.25	14.08
330.0	3706.12	3338.07	2629.01	1637.19	482.63	183.55	103.69	43.69	8.00
340.0	4707.86	5187.93	5676.00	5690.40	3853.34	808.11	155.06	63.37	11.84
350.0	5307.95	6663.34	8220.36	9450.93	7252.22	406.94	194.59	62.09	7.20
360.0	5203.93	6527.32	8863.65	11686.44	10119.82	916.93	224.19	64.33	10.40

Intensity data(cd)"

C/γ(°)	90.0	95.0	100.0	105.0	110.0	115.0	120.0	125.0	130.0
0.0	0.64	1.28	1.60	2.08	2.40	2.56	2.56	2.56	2.72
10.0	0.80	1.44	1.60	2.08	2.40	2.56	2.56	2.56	2.40
20.0	0.64	0.96	1.28	1.76	2.08	2.40	2.56	2.24	2.08
30.0	0.48	0.64	0.96	1.28	1.60	1.92	2.08	2.08	2.08
40.0	0.16	0.32	0.64	0.80	1.12	1.44	1.60	1.76	1.60
50.0	0.32	0.32	0.32	0.48	0.64	0.80	1.12	1.28	1.44
60.0	0.32	0.16	0.16	0.32	0.48	0.64	0.80	0.96	1.12
70.0	0.16	0.32	0.32	0.32	0.32	0.48	0.48	0.80	0.96
80.0	0.16	0.32	0.16	0.32	0.32	0.32	0.48	0.80	0.96
90.0	0.16	0.32	0.16	0.32	0.32	0.32	0.48	0.48	0.80
100.0	0.32	0.16	0.16	0.16	0.32	0.32	0.64	0.64	0.96
110.0	0.32	0.00	0.32	0.16	0.32	0.32	0.48	0.80	0.96
120.0	0.16	0.32	0.16	0.32	0.32	0.64	0.80	0.96	1.28
130.0	0.32	0.32	0.32	0.48	0.64	0.80	0.96	1.28	1.60
140.0	0.32	0.16	0.48	0.80	1.12	1.28	1.60	1.92	2.08
150.0	0.48	0.64	0.96	1.28	1.60	1.92	1.92	2.40	2.56
160.0	0.64	0.96	1.28	1.76	2.08	2.40	2.56	2.72	3.04
170.0	0.96	1.12	1.60	1.92	2.56	2.72	2.88	2.88	3.04
180.0	1.12	1.44	1.92	2.24	2.72	2.56	2.88	2.88	2.88
190.0	0.64	0.96	1.60	2.08	2.56	2.56	2.72	2.88	2.72
200.0	0.80	0.80	1.28	1.60	2.24	2.40	2.56	2.56	2.72
210.0	0.48	0.48	0.96	1.28	1.76	1.92	2.24	2.40	2.72
220.0	0.64	0.32	0.48	0.64	0.96	1.28	1.76	1.92	2.08
230.0	0.32	0.16	0.32	0.32	0.64	0.96	1.12	1.44	1.44
240.0	1.12	0.16	0.16	0.16	0.32	0.48	0.80	0.96	1.12
250.0	0.32	0.32	0.16	0.32	0.32	0.48	0.48	0.64	0.80
260.0	0.32	0.32	0.16	0.16	0.32	0.32	0.48	0.64	0.80
270.0	0.16	0.16	0.16	0.32	0.32	0.32	0.48	0.48	0.80
280.0	0.48	0.16	0.16	0.32	0.16	0.32	0.48	0.48	0.80
290.0	0.16	0.16	0.16	0.32	0.16	0.32	0.48	0.64	0.80
300.0	0.16	0.16	0.16	0.32	0.32	0.48	0.64	0.96	1.12
310.0	0.16	0.16	0.16	0.32	0.64	0.64	0.96	1.28	1.28
320.0	0.48	0.48	0.32	0.64	0.96	1.12	1.28	1.60	1.60
330.0	0.32	0.48	0.80	1.12	1.28	1.60	1.92	1.92	1.92
340.0	0.48	0.80	0.96	1.44	1.76	2.08	2.24	2.24	2.08
350.0	0.80	1.12	1.60	1.76	2.24	2.24	2.56	2.56	2.40
360.0	0.64	1.28	1.60	2.08	2.40	2.56	2.56	2.56	2.72

Intensity data(cd)"

C/γ(°)	135.0	140.0	145.0	150.0	155.0	160.0	165.0	170.0	175.0
0.0	2.72	3.20	3.36	3.20	2.72	2.56	2.56	2.24	2.24
10.0	2.72	3.04	2.88	3.04	2.72	2.56	2.40	2.40	2.24
20.0	2.40	2.56	2.56	2.72	2.40	2.40	2.24	2.40	2.24
30.0	2.08	2.24	2.40	2.24	2.24	2.40	2.40	2.40	2.24
40.0	1.76	1.76	1.92	1.92	2.08	2.08	2.24	2.24	2.24
50.0	1.44	1.60	1.60	1.76	1.92	2.08	2.08	2.24	2.24
60.0	1.44	1.28	1.60	1.60	1.92	1.92	2.24	2.24	2.24
70.0	1.12	1.28	1.28	1.44	1.60	1.76	2.08	2.08	2.24
80.0	1.12	1.12	1.44	1.60	1.60	1.76	2.08	2.24	2.40
90.0	0.96	1.12	1.28	1.60	1.76	1.92	2.08	2.24	2.24
100.0	1.12	1.28	1.44	1.76	1.76	1.92	2.24	2.24	2.24
110.0	1.28	1.44	1.44	1.76	1.92	2.08	2.24	2.24	2.24
120.0	1.44	1.60	1.60	1.76	1.76	2.08	2.24	2.24	2.24
130.0	1.60	1.76	1.92	2.08	2.08	2.08	2.24	2.24	2.24
140.0	2.08	2.08	2.08	2.24	2.24	2.24	2.40	2.24	2.24
150.0	2.72	2.72	2.56	2.40	2.40	2.24	2.24	2.40	2.24
160.0	2.88	2.88	2.88	2.72	2.56	2.40	2.40	2.40	2.24
170.0	3.04	3.36	3.04	2.88	2.72	2.56	2.56	2.24	2.24
180.0	3.20	3.04	3.04	2.88	2.72	2.56	2.40	2.24	2.40
190.0	3.20	3.36	3.36	3.20	2.88	2.72	2.56	2.40	2.24
200.0	3.04	2.88	3.04	2.88	2.88	2.72	2.56	2.40	2.40
210.0	2.56	2.56	2.72	2.56	2.56	2.40	2.40	2.40	2.40
220.0	2.24	2.08	2.24	2.24	2.24	2.40	2.40	2.24	2.24
230.0	1.76	1.92	1.92	1.92	1.92	2.08	2.24	2.24	2.40
240.0	1.28	1.44	1.60	1.76	1.92	2.08	2.08	2.40	2.40
250.0	1.12	1.28	1.60	1.60	1.92	1.92	2.08	2.24	2.24
260.0	0.96	1.28	1.28	1.60	1.76	1.92	2.08	2.24	2.24
270.0	0.80	1.12	1.44	1.44	1.60	1.92	2.08	2.24	2.40
280.0	0.80	1.12	1.44	1.44	1.76	1.76	2.08	2.24	2.24
290.0	1.12	1.28	1.44	1.60	1.76	1.92	2.08	2.24	2.24
300.0	1.28	1.44	1.44	1.60	1.60	1.92	2.08	2.08	2.24
310.0	1.44	1.44	1.60	1.76	1.92	2.08	1.92	2.24	2.24
320.0	1.60	1.76	1.76	1.92	2.08	2.08	2.24	2.24	2.24
330.0	1.92	2.08	2.08	2.24	2.40	2.24	2.24	2.24	2.24
340.0	2.08	2.56	2.72	2.56	2.56	2.40	2.40	2.24	2.40
350.0	2.72	2.88	3.04	2.88	2.72	2.56	2.40	2.40	2.40
360.0	2.72	3.20	3.36	3.20	2.72	2.56	2.56	2.24	2.24

Intensity data(cd)"

C/γ(°)	180.0
0.0	2.40
10.0	2.24
20.0	2.40
30.0	2.40
40.0	2.40
50.0	2.40
60.0	2.24
70.0	2.40
80.0	2.40
90.0	2.40
100.0	2.40
110.0	2.24
120.0	2.40
130.0	2.24
140.0	2.24
150.0	2.40
160.0	2.24
170.0	2.24
180.0	2.40
190.0	2.24
200.0	2.40
210.0	2.40
220.0	2.40
230.0	2.40
240.0	2.24
250.0	2.40
260.0	2.40
270.0	2.40
280.0	2.40
290.0	2.24
300.0	2.40
310.0	2.24
320.0	2.24
330.0	2.40
340.0	2.24
350.0	2.24
360.0	2.40





廣益全球驗證有限公司
新北市中和區橋和路120號9樓之二
TEL: 886 - 2 - 2248.0810
Fax: 886 - 2 - 2248.0811

Great One Global Certification Co Ltd
9F-2, No.120, Qiaohe Rd., Zhonghe Dist.,
New Taipei City 235, Taiwan (R.O.C.)
Email: sales@go-safety.com.tw

1. Luminaire Specification :

- (1) Input Voltage/Frequency : 220.1 V ac / 60Hz
- (2) Input Watt : 103.7 W
- (3) Input Current : 0.519 A
- (4) Total Luminous Flux Output : 10567.65 lm
- (5) Luminaire Efficacy : 101.91 lm/W
- (6) Central Intensity (cd) : 2774.790
- (7) Maximum Intensity(cd) : 11686.440
- (8) PF : 0.908
- (9) Beam angle : (C0-C180) 139.2 (C90-C270) 70.3

2. Description of EUT Setup :

- (1) Operating Orientation : The light source is considered as horizontal.
- (2) Light Source : LED
- (3) Stabilization time : 1 Hour
- (4) Environment Condition : Temperature: 25 ± 1 °C , Humidity: $60\pm 20\%$



廣益全球驗證有限公司
新北市中和區橋和路120號9樓之二
TEL: 886 - 2 - 2248.0810
Fax: 886 - 2 - 2248.0811

Great One Global Certification Co Ltd
9F-2, No.120, Qiaohe Rd., Zhonghe Dist.,
New Taipei City 235, Taiwan (R.O.C.)
Email: sales@go-safety.com.tw

3. Photograph of EUT :

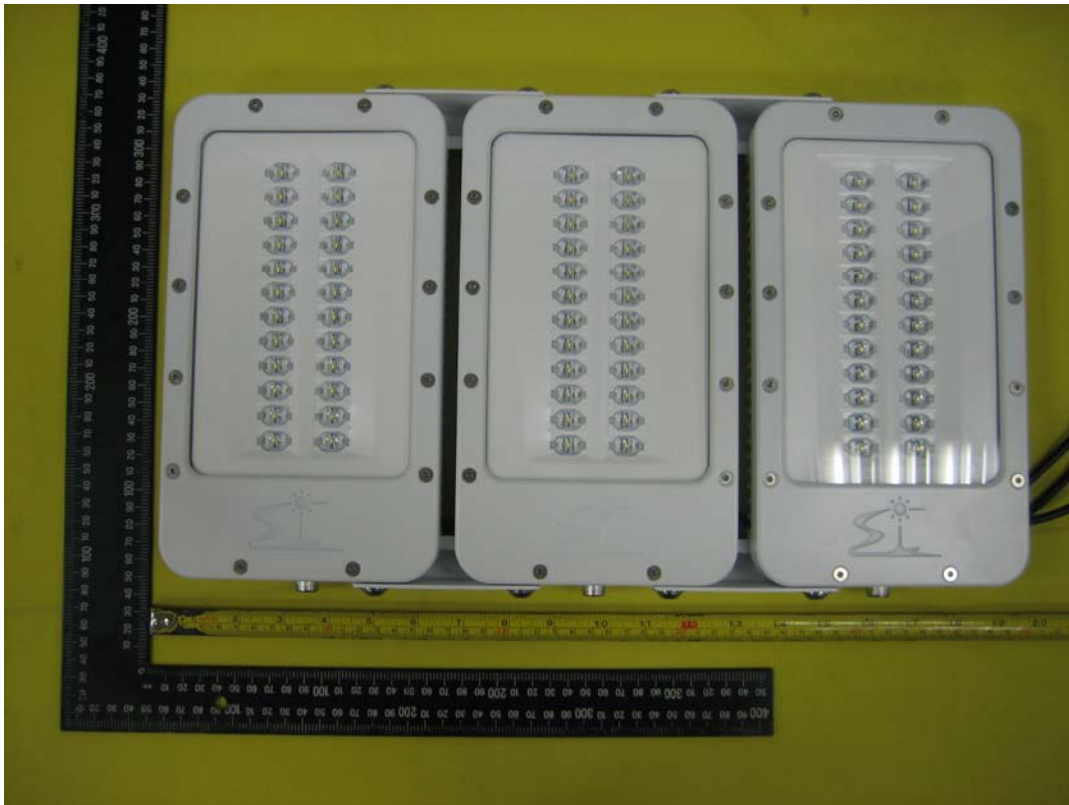
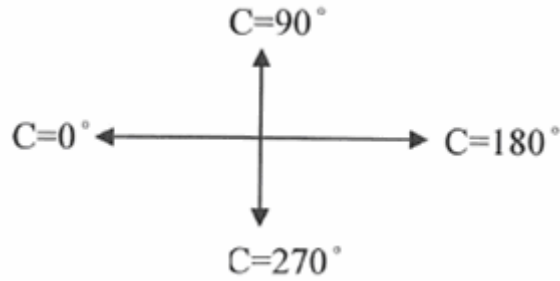



廣益全球驗證有限公司
新北市中和區橋和路120號9樓之二
TEL: 886 - 2 - 2248.0810
Fax: 886 - 2 - 2248.0811

Great One Global Certification Co Ltd
9F-2, No.120, Qiaohe Rd., Zhonghe Dist.,
New Taipei City 235, Taiwan (R.O.C.)
Email: sales@go-safety.com.tw

4. Equipments List:

Equipment ID	Equipment Type	Manufacturer	Model #	Cal. Date	Due Date	Range Used
L204	Goniophotometer-1800	SENSING	GMS1800	N/A	N/A	
L205	GMS-1800B Goniophotometer System	SENSING		N/A	N/A	
L206	AC Power Source	Twintex	TFC 500VA	N/A	N/A	
L207	Power Meter	SENSING	UI2008	2011/12/04	2012/12/03	V : Auto (0~300Vac) A : Auto (0~20A)
L210	Standard Lamp(100W)	SENSING	S01107	2012/01/05	2013/01/04	
L213	DC Power Source	ABM	PR9329	2012/03/21	2013/03/20	V : 0~30Vdc A : 0~5A
L221	Irradiance Standard lamp	SENSING	LSD1003029	2012/05/30	2013/05/29	